

# **FLEX** ELECTRIC BOILER



## **INSTALLATION MANUAL**

# Contents

---

EHS Electric Flex Combi and Flex System Boilers .....	4
Introduction.....	4
Health and Safety .....	4
ESSENTIAL INSTALLER CHECKS TO BE MADE PRIOR TO INSTALLATION.....	5
Installation Regulations .....	6
Installation of the boiler must comply with the following standards: .....	6
Unpacking and installation.....	6
Electric Boiler Schematics .....	7
EHS Flex System Single Phase (230V) System Boiler .....	7
EHS Flex Single Phase (230V) Combi Boiler.....	8
Installation Steps .....	9
Positioning and Wall Mounting the Boiler .....	9
Design and Connect the Plumbing System.....	10
Typical S plan Layout for EHS FLEX system boiler .....	10
Typical layout for EHS FLEX Combination Boiler .....	10
System Boiler Layout Design .....	11
Design Considerations.....	11
System Boiler Water Connections .....	12
Combi Boiler Layout Design.....	12
Design Considerations.....	12
HEATING SYSTEM – .....	12
HOT WATER SYSTEM.....	12
Flush and Fill Boiler.....	12
Electrical Connections .....	13
Electricity Connection Precautions .....	13
Thermostat Connections .....	14
Powering On the Boiler and setting the Parameters.....	15
Power On.....	15
Key Operating Function Descriptions.....	16
Full Display .....	16
Screen Symbols Description .....	17
Key Operating Instructions.....	18
To set and remove the boiler Child Lock.....	18
Purge Air out of the heating system.....	18

FLEX – Limiting the Maximum Power used on Heating.....	18
FLEX – Limiting the maximum power used on the Hot Water.....	19
Setting the Time .....	19
Setting the 24hr timer.....	20
Switch on Heating (Winter Mode).....	20
Frost protection function.....	21
<b>Set Pump Speed &amp; Purge Air</b> .....	21
Hot Water Setting (Combi Only) .....	22
Set Domestic Hot Water (DHW) Flow & Temperature .....	22
<b>Final check for Heating and Hot water.</b> .....	23
HEATING CHECK.....	23
Common Heating Start Up Issues:.....	23
HOT WATER CHECK.....	24
Common Hot Water Start Up Issues:.....	24
Registration for Warranty .....	24
PLUMBERS CHECKLIST .....	25
ELECTRICIANS CHECKLIST .....	26
Trouble Shooting For Qualified Installers.....	27
APPENDIX.....	30
EHS System Boiler 1 Phase Heating Circuit Diagram.....	30
EHS Combination Boiler 1 Phase Hot Water Circuit Diagram .....	31
Typical System Boiler S-Plan Wiring Centre Diagram for a Volt Free Boiler connection.....	32
Wiring Diagram for 3 Phase Combi Boiler Heating Circuit.....	33
Wiring Diagram for 3 Phase Boiler Heating Circuit .....	35
Technical Data .....	37
BOILER MAINTENANCE .....	38
WARRANTY INFORMATION .....	38

# EHS Electric Flex Combi and Flex System Boilers

---

## Introduction

The NEW EHS FLEX Electric Boiler range gives you the heating and hot water adaptability to suit all types of property size and make and years of trouble-free service. With our FLEX boilers the installer can size the heating power to suit the heat loss of the property on both the system and combi boiler versions. The hot water power can also be adjusted but we do not recommend reducing the power below 12kw if using for a shower.

Please follow the instructions as they will assist you in obtaining the best, trouble free performance and most economical settings for your appliance.

**ATTENTION: Only qualified engineers and approved service engineers are recommended for installing and servicing this product. Unqualified personnel and the use of nonstandard parts can be dangerous and will invalidate the manufacturer's warranty.**

**Please make sure you have performed all the necessary 'Essential Installer Checks' prior to opening the packaging, as we cannot take the product back if the packaging has been opened and the boiler has been put on the wall.**

The installation must be performed in accordance with current IEE Wiring Regulations, Building Regulations, Water Fitting Regulations (England and Wales) or Water Bylaws (Scotland) and all relevant British standards.

It is very important that you have read and fully understood this manual before installation of the EHS Electric Boilers to ensure their long life. This instruction manual should be kept in a place close to the appliance for easy reference. Please read the whole manual before attempting installation and follow these installation instructions and operating instruction to ensure long life of this EHS Boiler. These instructions must be conserved and given to any new user.

All EHS Electric Boilers are guaranteed from manufacturing defects for a full 5 years. To ensure that you are eligible for this guarantee you must register the boiler at [www.ehs-heating.com](http://www.ehs-heating.com) within the time specified in the warranty terms and conditions. This can be found at the back of this manual and on the EHS website. The warranty relates to any manufacturing defects and covers the replacement of any faulty parts. The guarantee does not cover any damage or faults that are a consequence of poor installation or faults caused by leaks within the boiler. It is therefore very important that all connections are thoroughly checked by the installer prior to leaving it with the customer. All work that takes place under the guarantee must be agreed with EHS prior to commencing the installation.

This appliance must only be used and programmed by an authorised adult. It should not be used by children or anyone who has not read the installation manual. If in doubt, seek expert advice.

## Health and Safety

---

At EHS we take every precaution to design and manufacture our products to meet all safety requirements, when installed and operated according to the correct procedures. All products are comprehensively examined and tested before despatch.

Under the Consumer Protection Act 1974 it is a requirement to provide information on substances harmful or hazardous to health (COSHH Regulations 1988)

Materials used in the manufacture of this appliance are non-hazardous and do not require any special precautions when fitting or servicing this appliance.

It is the responsibility of the user or engineer to use the correct Personal Protective Equipment and Clothing when installing or working on this appliance.

# ESSENTIAL INSTALLER CHECKS TO BE MADE PRIOR TO INSTALLATION

---

1. Carry out all heat loss calculations on the property and make sure that this boiler is suitable for the installation. EHS can assist with these calculations. Should you require this service please contact info@ehs-heating.com.  
HEAT LOSS CALC DONE?
2. For combination boilers you will need to carry out a hot water calculation to ensure that the boiler has sufficient heat output to provide the correct temperature & flow of water required for the application. This will depend on flow rate required. If you need help calculating this, please contact info@ehs-heating.com.  
HOT WATER CALCULATION DONE?
3. Check the mains water pressure - The maximum pressure of the units is 6bar, where water pressure is close to or varies around this limit a pressure reducing set on the mains supply should be installed.  
MAINS WATER PRESSURE CHECK OK?
4. Check that the power supply to the premises meets the minimum requirements of the unit being installed.  
PREMISES POWER SUPPLY SUFFICIENT?
5. Carry out a voltage and load test to determine the correct sized cable and breaker is used.  
VOLTAGE AND LOAD TEST DONE?  CABLE SIZE mm?  BREAKER (AMPS)?
6. Check the central heating design is suitable for the application (Detailed recommendations are provided in BS EN 12828 and BS EN 6700.)
7. SYSTEM DESIGN COMPATIBLE WITH PART L OF THE BUILDING REGULATIONS
8. If installing a combination boiler, check that the hot water flow rate from the boiler will be sufficient for the application (typically 6 to 7 litres per minute for a 14kw combi)  
HOT WATER FLOWRATE OF COMBI BOILER SUFFICIENT?
9. When siting the boiler, consider the requirements for servicing the boiler (i.e. space around and in front of the boiler) and ensure that it is fitted in a location that cannot be accessed by unauthorised/unqualified people or children.
10. Make sure that this boiler is not installed in a shower compartment or bathroom.
11. The boiler must be installed in an upright position.
12. Check that the boiler will be mounted on a suitable wall that can bare the weight of the boiler.
13. Ensure that all six fixing points are used when fixing the boiler to the wall.
14. Please make sure you have performed all the necessary checks above prior to opening the packaging, as we cannot take the product back for a free return if the packaging has been opened.
15. Finally, you can unpack the boiler from its packaging.
16. PLEASE NOTE EHS ARE NOT RESPONSIBLE FOR ANY FAILURES SHOULD THE ABOVE TERMS NOT BE MET

## Installation Regulations

---

Installation of the boiler must comply with the following standards:

1. The local building regulations
2. UK building regulations
3. BS EN 12828 - Heating systems in buildings: Design for water-based heating systems.
4. BS EN 12831 - Heating systems in buildings: Method for calculation of the design heat load.
5. BS EN 14336 - Heating systems in buildings: Installation and commissioning of water-based heating systems.
6. BS7671 - Requirements for electrical installations. IEE Wiring Regulations. Seventeenth edition.
7. BS EN 7593 - Code of practice for treatment of water in heating systems

## Unpacking and installation

---

1. These appliances can weigh up to 30kg so please be aware that you will need 2 people to manually move and unpack the appliance.
2. Cut the seals as detailed below taking care not to penetrate inside the box otherwise this may scratch the appliance.
3. Fold the box lids back and remove the polystyrene packing
4. With one person at either end, lift the boiler gently out of the box.
5. Box Contents
6. Electric Boiler
7. Pipe Positioning Template
8. Wall mounting guide
9. Labels and Instructions
10. Expanding Wall bolts.

# Electric Boiler Schematics

## EHS Flex System Single Phase (230V) System Boiler

No.	Part	No.	Part	No.	Part
001	Expansion Vessel	006	ERP Pump	011	Current Sensor
002	High Temp Sensor	007	3 Bar Blow off Valve	012	Thermal Reset Switch
003	Flow Temp Sensor	008	Paddle Flow Switch	013	Display board (Front)
004	Pressure Gauge	009	Main Circuit Board	014	0 Volt Thermostat Connection
005	Pressure Sensor	010	Cable Gland	015	

Note: When ordering spares parts please quote FLEX -

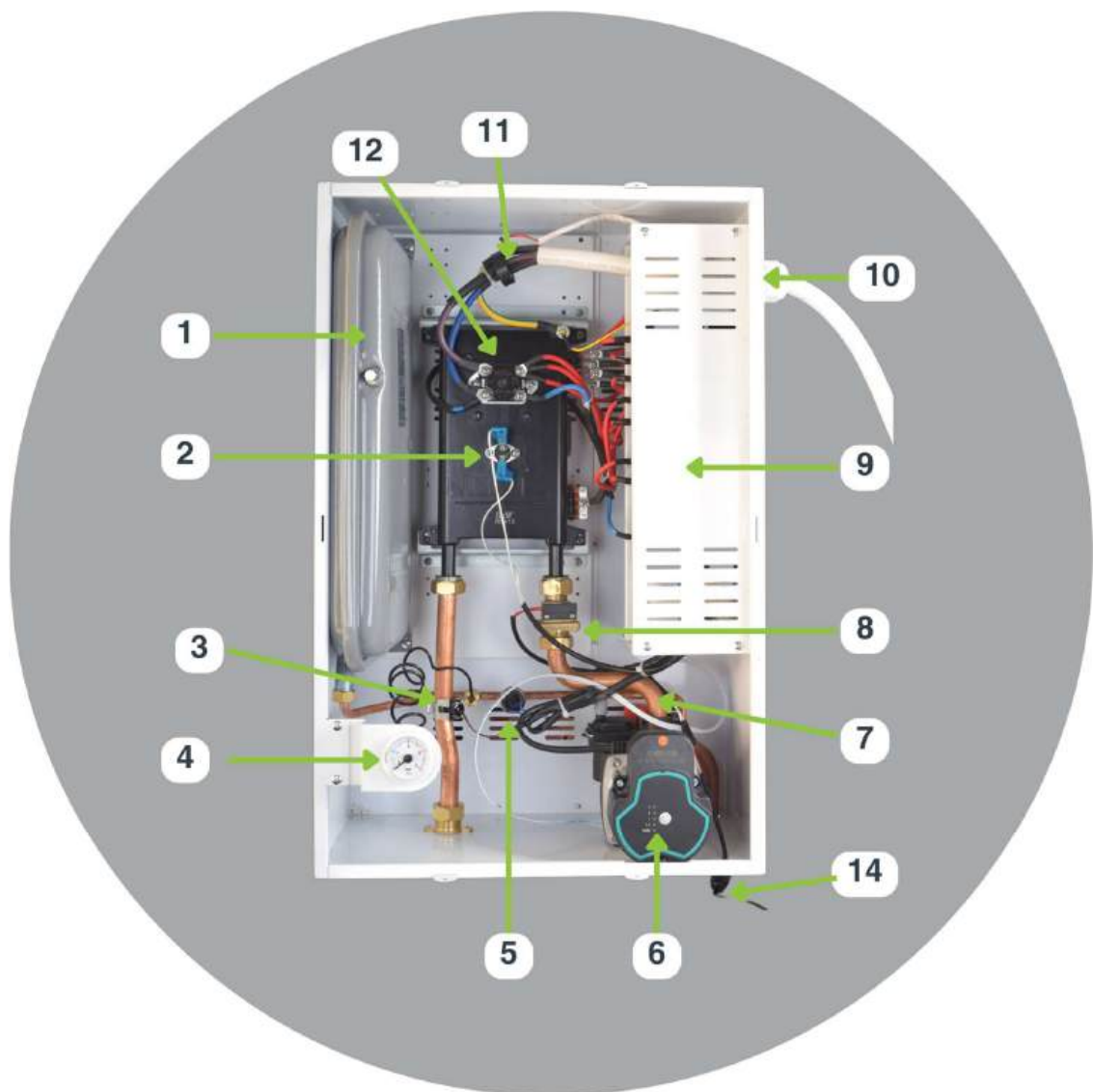

## EHS Flex Single Phase (230V) Combi Boiler

No.	Part	No.	Part	No.	Part
001	Expansion Vessel	006	ERP Pump	011	Current Sensor
002	High Temp Sensor	007	3 Bar Blow off Valve	012	Thermal Reset Switch
003	Flow Temp Sensor	008	Hot Water Flow Sensor	013	Display board (Front)
004	Pressure Gauge	009	Main Circuit Board	014	0 Volt Thermostat Connection
005	Pressure Sensor	010	Cable Gland	015	SCR Boards for Hot water control

Note: When ordering spares parts please quote FLEX –

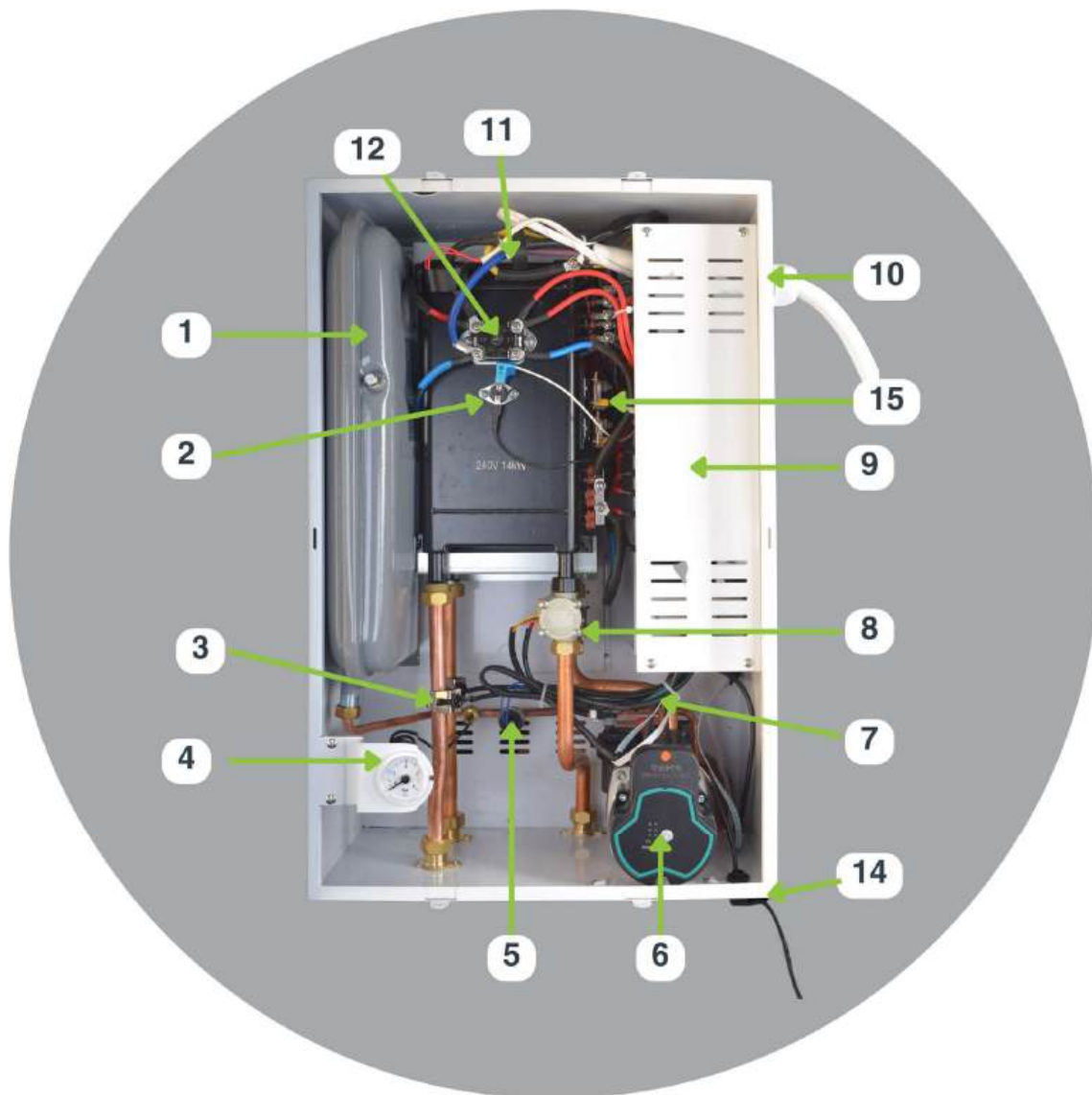

# Installation Steps

## Positioning and Wall Mounting the Boiler

### IMPORTANT:

When choosing a location to mount the boiler it is important that you consider clearance, servicing of the boiler, and safe operation.

The boiler should be fitted out of the reach of children or protected against people without the right skills and qualifications (there is a lock that can be set on the boiler). If there is the possibility that the boiler could be opened without first isolating the electrical supply then you must install it in a fashion that prevents access to the boiler, such as a lockable cupboard.

The wall that you choose to mount this boiler on should be strong enough to support the boiler when full.

EHS recommend at least 100mm clearance from all fixed obstructions on all sides of the boiler. Allow plenty of space at the base of the boiler for fitting the hot and cold-water pipes and isolation valves.

**Step 1.** Drill 5 holes as per the included wall mounting diagram. The upper 3 holes should be  $\Phi 8$ mm diameter, and the lower 3 holes  $\Phi 6$ mm.

**Step 2.** Secure the 3  $\Phi 8$ mm expansion bolts into the top three holes

Fig 1 Fig 2

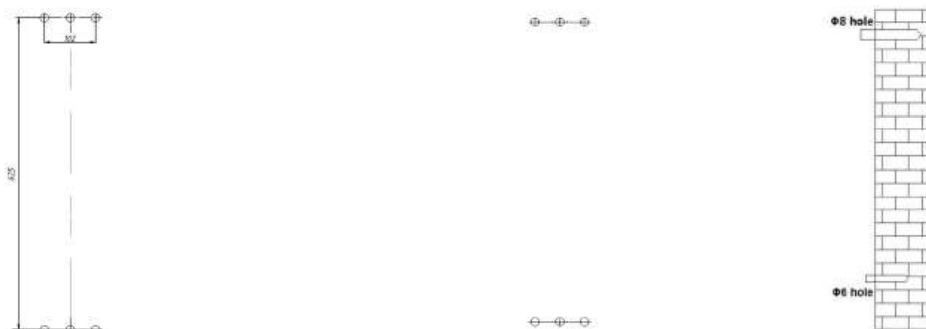

**Step Three :** Hang the boiler from the top three bolts before securing the boiler to the wall using standard fastenings at the bottom

Screw 3 x screws into 3 upper expansion bolts

**Step Four:** Hang the boiler on the 3 fixed expansion bolts. Then drill 3 screws into lower positions.

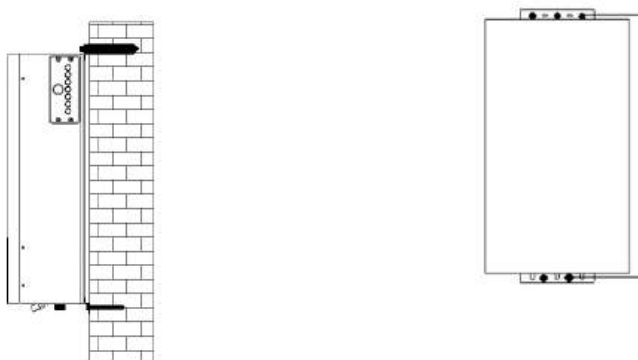

## Design and Connect the Plumbing System

### Typical S plan Layout for EHS FLEX system boiler with Bath

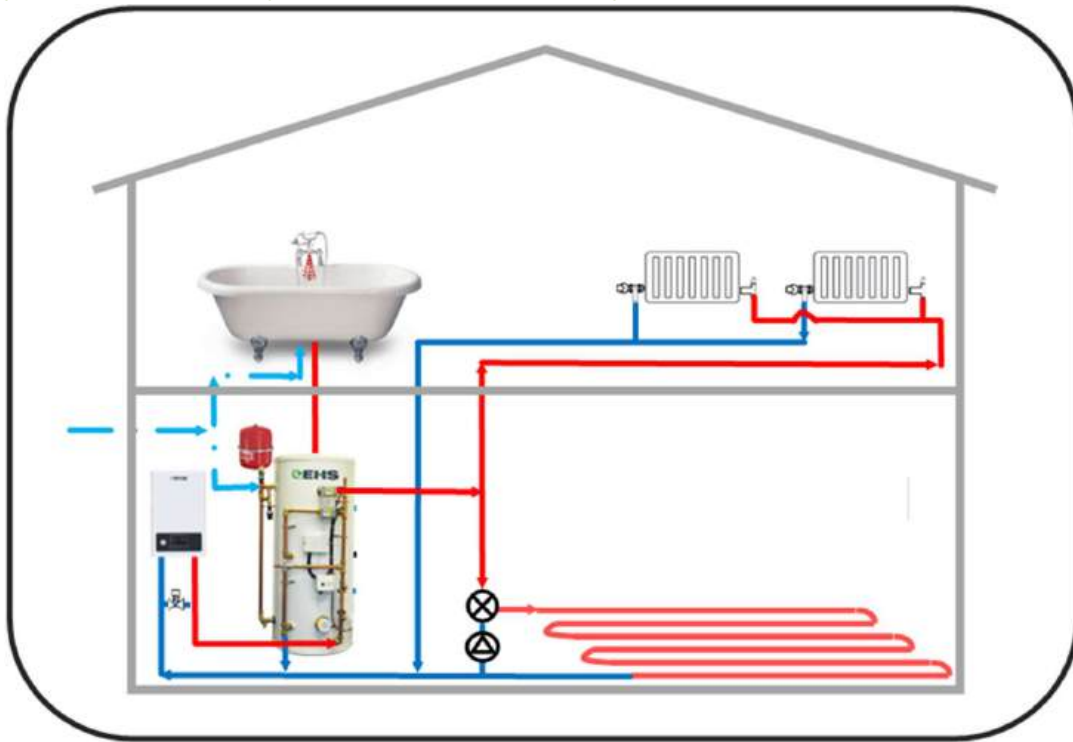

### Typical layout for EHS FLEX Combination Boiler with Shower

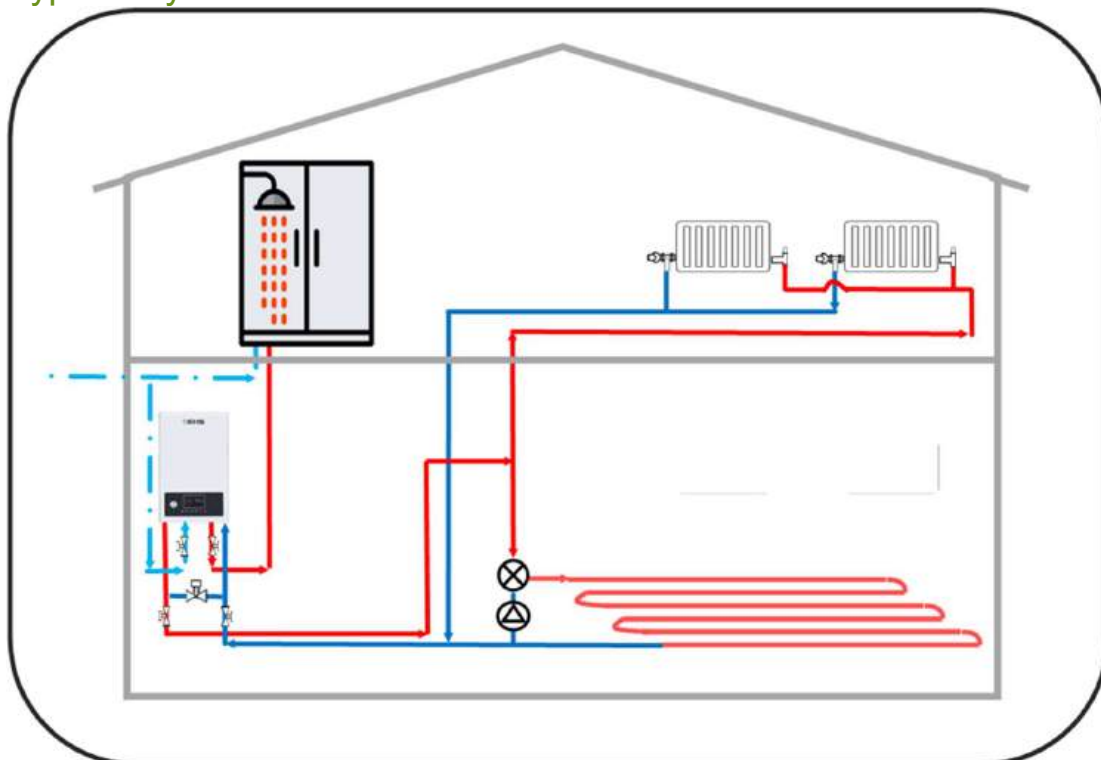

Note: The Layouts illustrated above are for guidance only. Please ensure that the system is designed and installed by a qualified heating engineer in line with current legislation.

# System Boiler Layout Design

---

## Design Considerations

The boiler must be installed by a qualified heating engineer and a qualified electrician. The installation must be designed to meet the current building regulations. EHS Limited are not responsible for faulty installations or installations that are undertaken by unqualified people.

**HEATING EXPANSION VESSEL** A 5ltr expansion vessel is fitted internally within the boiler to provide room for thermal expansion of water under regular operating conditions. If the system contains significant volumes of water, an additional heating expansion vessel conforming to the current issue of BS4814 should be fitted externally. For any system an accurate calculation of vessel size is given in the current issue of BS5449 and BS7074 part 1.

**AUTOMATIC BYPASS VALVE (ABV) - An ABV MUST be installed as part of this installation.**

The ABV should be fitted to begin opening immediately the first radiator, valve or actuator shuts in the system. This stops excess pressure from building in the system on the flow side and ensures the heating system flow is maintained. **Failure to fit and set the ABV can result in an F6 error code or complete boiler shutdown. It will also result in poor performance and premature boiler failure. Failing to fit an ABV will affect the warranty.**

**ISOLATION VALVES:** EHS recommend that **full bore isolation valves** are fitted on the flow and return pipework of the boiler. Standard ball valves will restrict flow and impede the flow in and out of the boiler which will result in poor performance.

**AUTOMATIC AIRVENTS:** The EHS Boilers have a built-in automatic air vent behind the pump. If, however, the boiler is to be used alongside a hot water cylinder or you have pipework that is above radiators and could trap air, you should fit additional air vents in the highest points within the system or as appropriate. If you find that your boiler is the highest point in the system, it is always wise to design the pipework so that you can flush air out of the boiler using the filling loop to fill the system and the drain to expel the air.

**SYSTEM FILLING:** A WRAS approved filling loop must be used in such a way that it never becomes a permanent connection between the mains water and the heating system. The heating system should be filled to 1.5bar when cold and topped up accordingly during commissioning. Please refer to BS EN 14336.

**MAGNETIC FILTER:** An inline magnetic filter should be fitted on the return side of the heating circuit to protect the boiler from debris from the heating system. This should be checked at every service interval or before if there is poor flow in the system. Under BS7593 and the new 2022 legislation, it is recommended you treat your system with an inhibitor to prolong the system, then Biocide to prevent bacterial build-up, if using with UFH with low-temperature heating. Failing to fit a magnetic filter will affect the warranty.

**DRAIN POINT** A drain point should be fitted at the lowest point of the heating system. It is not acceptable to drain the boiler through a safety valve as debris can prevent the correct operation of the valve

**Contact your local supplier or EHS to purchase our recommended 'EHS System Boiler Installation Kit'**

## System Boiler Water Connections

---

**Flow & Return Connections.** Flow & Return connections are G 3/4" male thread. Use 2 x 3/4" female to 22mm pipe adapters along with 2 x full bore isolation valves to provide good system circulation. Care must be taken not to overtighten connections as this can twist and damage the internal pipework of the boiler (which is not covered under the warranty). An external magnetic filter must be used on all installations.

**PRV.** The boilers are fitted with a pressure relief valve. This has a 15mm copper pipe which should be discharged as per current building regulations. The PRV should never be used as a drain point as this could cause the device to leak.

**Insulation.** We recommend that all pipework is insulated where practical, especially the primary pipework within a boiler cupboard. This will reduce heat loss and protect the cupboard from high temperatures.

## Combi Boiler Layout Design

---

### Design Considerations

As for a system boiler, it must be installed by a qualified heating engineer and a qualified electrician. The installation must be designed to meet the current building and lee regulations. EHS Limited are not responsible for faulty installations or installations that are undertaken by unqualified people.

14kw Combi boilers are suitable for properties with a single shower. We do not recommend them for properties with baths as the flowrates of approx. 6ltr/min will not suffice to fill a bath quickly enough.

24kw 3 Phase Combi Boilers are suitable for properties with baths but not many properties in the UK have a 3 Phase supply.

A property with a bath would ideally have a system boiler and a hot water cylinder.

**HEATING SYSTEM** – The heating system should be designed as per the SYSTEM BOILER Layout design in the previous chapter.

### HOT WATER SYSTEM.

**FLOW RESTRICTION.** The Flex combi boilers have a heat exchanger with a maximum power of 14kW to heat the hot water. As the boilers are range rateable the maximum power can be adjusted lower to suit the requirements. We do not recommend it being adjusted any lower than 12kw if you have a shower in the property. At full power of 14kw the boiler will raise the temperature of the incoming water by 30°C at a flow rate of 6.5 litres per minute. This means that the flowrate of the incoming mains must be restricted to between 5 and 6 litres per minute to ensure that it delivers water hot enough for showers (39°C is a normal shower temp) when the incoming mains temp is low.

The best way to restrict the flow of water to the boiler is with a set flow restrictor of 5 or 6 litres per minute. We supply a 5l/min flow restrictor with our Installers kit that ensures there is always hot water even on the coldest days.

### Flush and Fill Boiler.

**Flushing:** The primary Heating circuit must be flushed according to BS7593. The system must be flushed with 10% of mains PPM or lower to ensure there is no debris trapped in the heating system, which would be detrimental to the lifespan of the boiler.

**Heating System Fill.** A WRAS approved filling loop must be used in such a way that it never becomes a permanent connection between the mains water and the heating system.

## Proceed as below

1. Open the isolation valves that you have fitted to the flow and return of the heating system near the boiler.
2. Connect the filling loop.
3. Open filling loop so that it fills through the boiler (to remove air from the boiler) and fill the system slowly checking for leaks on the connections as you do. Fill until the pressure on the pressure gauge reads between 1 and 1.5bar, then close the filling loop connection.
4. Vent the air out of the system and repeat the stage above
5. Check the system (including the inside of the boiler) for leaks. Please allow at least an hour of normal operation to confirm all fittings are leak free.
6. Where the boiler is the highest point in a system, it is a good idea to fit a vertical automatic air vent (AAV) on a horizontal return pipe from the heating system and possibly even a drain valve on the flow side of the boiler so that the boiler can be flushed through to remove air from the heat exchanger.

## Electrical Connections

All electricity connections to the boiler must be made by a fully qualified electrician. Improper electric connections made by unqualified people may cause failure of critical components of the boiler and will invalidate the warranty.



### **DANGER! Electric Shock Risk**

Make sure to isolate the main power supply before starting work inside the boiler. Secure the main energy supply to prevent from turning on while working on the boiler.

### **IMPORTANT NOTICE**

**UNDER NO CIRCUMSTANCES MUST THIS BOILER BE CONNECTED TO THE MAINS POWER WHILST THE BOILER IS DRY.**

**THE BOILER MUST BE FILLED WITH WATER AND PRESSURE TESTED PRIOR TO ELECTRICAL CONNECTION.**

**FAILURE TO DO SO WILL DAMAGE THE BOILER AND INVALIDATE THE WARRANTY**

## Electricity Connection Precautions

We recommend that a load check is carried out when installing high power boilers.

All electrical connections must be made by a fully qualified electrician.

All wiring must be carried out in accordance with current IEE BS7671 wiring regulations. The supply cable to the boiler should be of sufficient size to carry the load capacity required. We recommend a high temperature multi strand flexible cable like HO5 or HO7 standard cable be used inside the boiler.

Rated Boiler Output	7kW	9kW	12kW	14kW
Single / Three Phase	Single	Single	Single	Single
Rated Voltage	230VAC	230VAC	230VAC	230VAC
Current (A) @ Rated Voltage	26	34	52	61
Minimum MCB/RCB (A)	32	40	63	63
Minimum Cable Size (mm <sup>2</sup> )	6	6	10	10

An upgrade to the main fuse of the property may be required.

As well as the boiler being properly earthed, this appliance requires supplementary earth bonding across all pipes connected to the boiler.

Surge protection devices must be installed within the installation in-line with regulation 443 of BS7671. We recommend fitting an appropriately sized external RCD near to the boiler.

### Electrical Supply Connections

There is 650mm length HO5 cable supplied with the boiler at the recommended diameter. The connections are already made within the boiler so there is no need to remove the cover to connect to the mains supply. We recommend fitting an appropriately sized rotary isolator or RCD next to the boiler so that it can be easily isolated if any work needs to be completed inside the boiler.

## Thermostat Connections

The boiler cannot control external temperature and therefore an external thermostat and programmer should be used to control the boiler to schedule the hot water and heating. This is a **ZERO VOLT** connection, so **DO NOT** connect any power to the thermostat cable from the boiler.

**Any live supply to the boiler thermostat wire will damage the main electronics boards and will immediately invalidate the warranty.**

Thermostats can be fitted as a single programmable thermostat or as an individual programmer and thermostat.

Thermostats must be fitted by a competent person, and installation must comply with the guidance provided in the current editions of BS767 (IEE wiring regulations) and part "P" of the building regulations.

There is a 230V 3amp Auxiliary live supply available within the boiler or the thermostat can be supplied by an external fused spur with either a 6amp or 3amp fuse depending on your thermostat.

Please see wiring diagrams and pictures in appendix for the boiler auxiliary supply and typical wiring centre connections for S Plan system

The Zero volt thermostat connection to the boiler is provided externally on the bottom right of the boiler. Do Not supply any power to this connection.

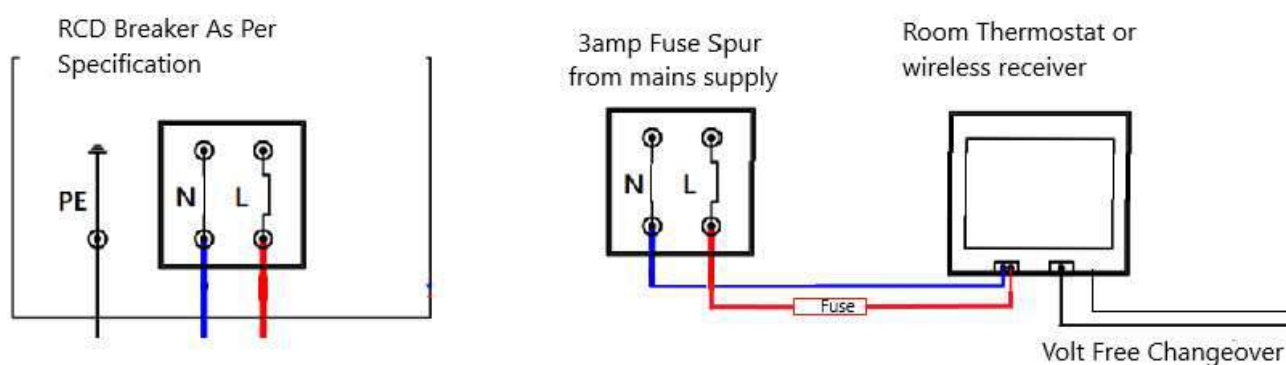

# Powering On the Boiler and setting the Parameters

---

## Power On

Before any power is turned on to the boiler it is important that it is checked for any loose connections. Check all connections including the factory-made ones as these can come loose in transit.

Prior to turning the boiler on for the first time, please make sure you have completed the following:





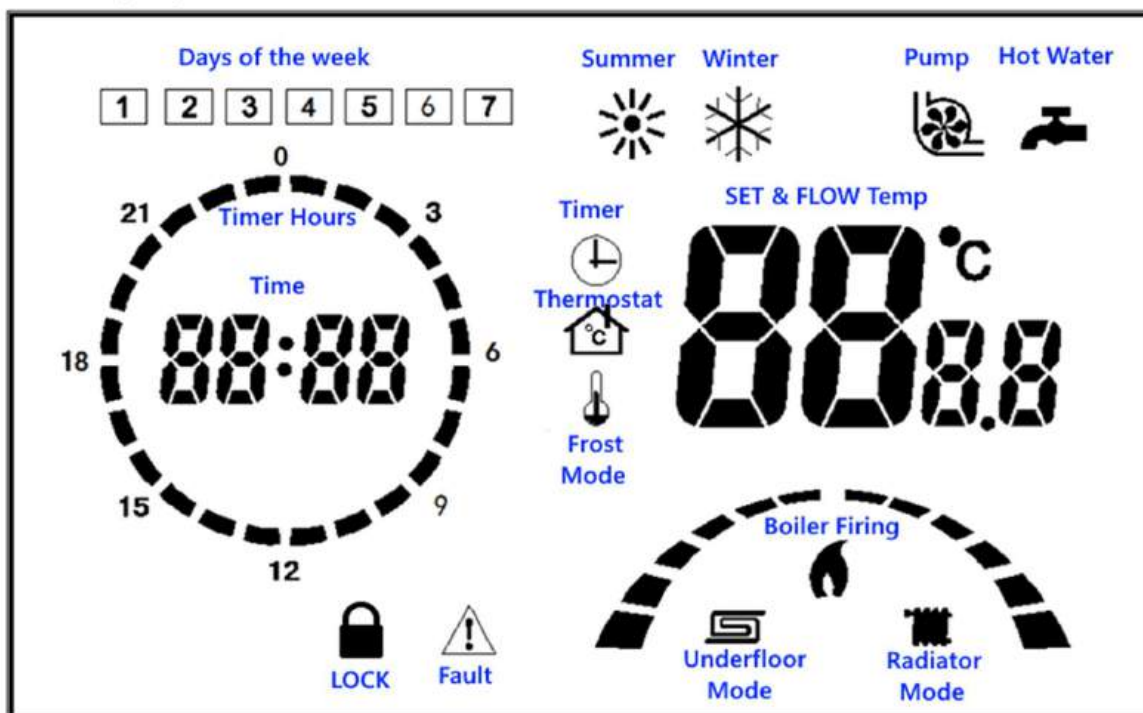

1. All STEPS in the manual so far, have been completed as instructed. The boiler must have been filled with water and isolating valves must be in the open position.
2. The boiler casing is closed and secured.
3. Set the thermostat to the off position or lowest possible temperature.
4. By activating the appropriate RCD breaker in the consumer unit (or preferably next to the boiler) external to the boiler, this will put the Boiler into standby mode. Don't press the power on button yet but leave it in standby mode until the system parameters can be configured.

# Key Operating Function Descriptions.

















## Full Display



On/off      Mode      UP      Down      Timer      OK/Enter

Button	Function	Button	Function
 <b>ON/OFF</b>	Press and hold for 3s to turn on/ turn off. In the 'Engineer Codes' setting state, it is used as the confirm and exit key. Press to clear the fault state.	 <b>UP</b>	When temperature is flashing, press and hold for 3s to quickly adjust the temperature of the heating outlet water up.
 <b>OK/ENTER</b>	When in parameter setting ,this switches from the parameter to the data values When in timer setting, this switches between "mins" and "hours" Hold press 5s to reset boiler in error state.	 <b>TIME</b>	Hold press to enter the timing setting
 <b>MODE</b>	Toggles between Winter and Summer Modes	 <b>DOWN</b>	Hold press 3s to quickly adjust the temperature of the heating outlet water down Short press to set temperature





## Screen Symbols Description

Symbol	Description	Symbol	Description
	1. When Lit means boiler is in Winter Mode – Heating and Hot Water are active 2. Flashing means entering frost protection state		Radiator Central Heating Mode Temp 30~80°C
	When lit the boiler is in summer mode i.e. no heating, hot water only		Underfloor Heating Mode Temp 30~60°C
	Timer heating		Error Mode – Error code should be visible
	Pump working		Current time
	Flame and Semicircle are lit when the boiler's heating elements are on and heating the water.		Displays the current heating water temperature under normal conditions. When adjusting the temperatures it will show the set temperature but revert to the actual temperature .
	Hot water flow rate		24h timer
	When lit: No call for heating (the room thermostat is off, or there is no call for heat or it is not connected) When not lit : Call for heat from thermostat or thermostat wires are linked together to force the boiler to fire		Hot water mode is activated. This signals that the flow sensor is working and is measuring a flow above 3l/m in the hot water circuit. This activates the Hot water to fire (Combi boiler only)
	Days of the week		Frost protection mode
	Boiler Lock – When lit the boiler controls will not work. Press tick button twice to remove lock		



## Key Operating Instructions

---

### To set and remove the boiler Child Lock

When the boiler Lock symbol  is showing, the boiler cannot be operated via the control panel until the lock is removed. This can be set and removed by pressing the up  or down  buttons at the same time until LP OF shows where the digital clock is. Press the TICK  button until OF is flashing. Press up to button to change to on. Do the same to turn off.

### Purge Air out of the heating system

With the boiler in standby mode (OF should be showing on the main screen) press and hold the ON/OFF button  and the Menu button  together for 3 seconds. The pump symbol  should be lit showing that the pump is running. Run the pump for 20 mins to clear the air from the system. If F6 shows you have NO FLOW in the heating system which is usually caused by a closed valve or an airlock. Vent all radiators and refill the system.

### FLEX – Limiting the Maximum Power used on Heating

Our boilers are supplied with a Maximum heating output of 14kW and 7kW at 240v for the single phase boilers and 24kW for the 3 phase boilers. The output can be rated below this maximum to match the heat load required at the property in order to reduce cycling and save money.

**Please scan the QR code below to enter our Installers Online Support pages in order to range rate the boiler. Please note that you must be a qualified electrical installer if you are to range rate the boiler and fuses lower than the maximum recommended**



**WARNING:** Please note that if de-rating a combi boiler, the cables and RCD breaker must match the highest demand. The supply cable to the boiler should be of sufficient size to carry the load capacity required. It should be wired through a linked isolator switch with minimum contact gaps of 3mm in every pole and protected by a suitably rated circuit breaker RCD.

Install the necessary electrical protections as Indicated In the current regulations.

In the event of these regulations not being complied with, the manufacturer will not be liable for any bodily injury or material damage that may occur.

It is essential that the boiler is properly earthed, and the wiring tested to the Latest IEE regulations

**WARNING:** On installations where the incoming power supply is not capable of maximum load the boiler control must be re-configured to limit the output before switching on.

**CAUTION:** It is essential to confirm the power output with the use of a clamp meter after set up

Rated Boiler Output	2.3kW	4.6kW	7kW	9.3kW	11.7kW	14kW
Boiler UH Parameter Setting	01	02	03	04	05	06
Single / Three Phase	Single	Single	Single	Single	Single	Single
Rated Voltage	230VAC	230VAC	230VAC	230VAC	230VAC	230VAC
Current (A) @ Rated Voltage	10.4	20.9	31	42	52.2	62.6
Minimum MCB/RCB (A)	32	32	32	50	63	63
Minimum Cable Size (mm2)	2.5	4	6	10	10	10

## FLEX – Limiting the maximum power used on the Hot Water

The maximum power used for the hot water can be limited down. We don't recommend lowering the power past 12kw for properties with showers due to flow rate restrictions or 10kw for properties with just wash hand basins. Ensure the boiler thermostat wires are apart and there is no call for heat or hot water.

**Please scan the QR code below to enter our Installers Online Support pages in order to range rate the boiler. Please note that you must be a qualified electrical installer if you are to range rate the boiler and fuses lower than the maximum recommended**



Rated Boiler Output	2.3kW	4.6kW	7kW	9.3kW	11.7kW	14kW
Boiler UH Parameter Setting	01	02	03	04	05	06
Single / Three Phase	Single	Single	Single	Single	Single	Single
Rated Voltage	230VAC	230VAC	230VAC	230VAC	230VAC	230VAC
Current (A) @ Rated Voltage	10.4	20.9	31	42	52.2	62.6
Minimum MCB/RCB (A)	32	32	32	50	63	63
Minimum Cable Size (mm2)	2.5	4	6	10	10	10

## Setting the Time

Turn on the boiler . Temperature should be solid **88<sup>°</sup>** and not flashing, Press up and hold for 3s to enter the timer setting. You should see the hours flashing on the clock.







Adjust the hours by pressing up or down as required, Press OK/ENTER to switch between 'min - hour – day of week', press UP/DOWN to adjust each accordingly.

After the setting is completed, it will automatically save and exit after 10s, or press the power button  to save and exit.

### Setting the 24hr timer.



We do not recommend using the boilers internal timer as this will confuse any programmable room thermostat that is fitted to the heating system, If, however, you have a system that does not need an external thermostat, then you can use the boilers own internal clock to control when the boiler is ON and when it is OFF. This function does not have separate controls for hot water and heating and will still be dependent on a control on the thermostat to demand heat.







Switch the boiler on 

Press the timer  key until the hour timer starts flashing. Press  UP/DOWN  to choose the hour (01 is 1am 13 is 1pm). Press the OK/ENTER  and then set ON or OF by pressing the UP/DOWN keys. (If the segment is lit  then the boiler will be on and if it is not lit  it will be off) Once you have set your timing schedule press  to save the settings.









### Switch on Heating (Winter Mode)

Ensure you have between 1-1.5bar of pressure on the central heating system pressure dial, on the main panel and you have purged the heating system of air (as above). Turn the boiler on by pressing the ON/OFF  button for 3 seconds.

A temperature will appear on the front panel. This is the current heating flow temperature that the boiler is measuring. Switch between winter  (Heating and Hot Water) and summer  (Hot water Only) modes by pressing .

For heating the boiler must be in winter mode . When this is lit and there is a demand for heat, the pump will start running, . The boiler will now check for flow in the heating system before firing the heating elements. If there is no flow in the heating system an F6 error will occur. Please check the system for closed vales, airlocks and vent all radiators again. When the boiler senses flow and confirms the current flow temperature is below the set temperature the heating elements will be powered on and the heating symbol,  will start working. The boiler will show the current flow water temperature . The target or set flow temperature can be changed by pressing either the up  or the down  keys.

If you want to stop the heating then you can turn the boiler off but this will also stop the Hot water. It would be better to put the boiler into summer mode.

**Underfloor heating mode** is accessed via the engineers control panel. When the boiler is in underfloor heating mode  the temperature is set between 30 and 60°C. When the boiler is set in radiator mode  the heating system can operate between 30 and 80°C. To enter the engineers panel press the  button 8 times. - CS 01 will show – this is the under floor or radiator system setting. CS will be flashing. Press  button again and it will move so the 01 is flashing. Press up  or the down  keys to toggle between 01 and 00. You should see the  symbol and the  symbol change at the same time. Once set press  to save the setting.

## Frost protection function

**Note: Frost protection is only available in winter mode.**

### First level of frost protection

When the boiler is off but there is still power to it, it monitors the internal temperature. If this drops between  $6\text{C} \leq X \leq 10\text{C}$ , the boiler will enter the first-level frost protection state and the water pump will turn on, until the heating outlet temp.  $\geq 11\text{C}$ . After that the pump continues to run for 1min and it will exit the first-level frost protection.

### Second level of frost protection

If the first level of frost protection does not work and the temperature drops between  $2\text{C} \leq X \leq 5\text{C}$ , the boiler will enter the second-level of frost protection where the system turns on the power to control the heat exchanger, when there is no fault, until the heating outlet temp  $\geq 15\text{C}$ . After the heating system continues to heat for 1min, it will exit the secondary frost protection state.

For setting all other functions see 9.1

## Set Pump Speed & Purge Air

The Boiler should still be in standby mode.

Please check the following before proceeding.

The boiler parameters have been set as above.



The air vent on the pump is open (dust cap is moving freely).

Set the pump to speed 1.

The boiler can now be activated

Turn On the Boiler –

Press and hold the power button until the boiler beeps and exits standby mode. It is most likely to be in summer mode  (Hot Water only mode).

If you have fitted an external thermostat, turn the required temperature to low/off so there is no demand for heating and the  symbol will light up to infer that the house is up to temperature (if the thermostat is fitted correctly). The boiler should then be turned to winter mode  (Heating and Hot water)

Set The Thermostat –

Turn the thermostat on and set to a temperature that would require heat. The thermostat  symbol will go out. The pump will start and a few seconds later the flame symbol will appear lit, showing that the boiler has started to heat the water.

Purge Air from The System –

With the pump running start to purge all air from the system by bleeding all radiators and air vents. Once bled the system should run with very little noise coming from the boiler or pump.

#### Set Pump Speed –

Set this by adjusting the pump speed to achieve a 15 ~ 20°C differential between the flow and return temperatures.

#### Set Automatic Bypass Valve –

Set all TRV's to the open position (i.e.max temp). Now set the ABV to 'just closed'. To confirm this is correctly set, close one of the TRV's and that should allow a small amount of flow past the ABV.

#### Check System Pressure and Top Up As Required –



Don't forget to disconnect the filling loop and ensure that all connections are capped to avoid leaks.



## Hot Water Setting (Combi Only)

The hot water setting is only available in the combination boilers. It has a separate heat exchanger to the heating circuit and therefore is operated independently. Hot water will take priority over the heating circuit, therefore if there is a demand (i.e. someone opens the hot tap or starts a shower) the boiler automatically senses the demand and switches the power from the heating circuit to the hot water circuit. The flow of water must exceed 3litres per minute for the heater to start. Hot water flow rates are dependant on 3 variables.

- 1 the incoming mains water temperature (UK Avg 8°C in January to 20°C in August)
- 2 the temperature the hot water has been set to (30~60°C) ( different to the heating set temperature) and
- 3 the flow of water (eg a 14kw electric boiler will give a 30 degree rise in temperature at a 6~7l/min flow rate)

When the boiler is on and the water flow exceeds 3L per minute, the hot water function is automatically activated .

Press  to switch to summer mode  after the winter season over and the heating system will only supply hot water on demand.

The Hot water temperature can be set between 30°C ~ 60°C. To do this press up  or the down  keys to set the max temperature and then adjust the flow rate according to achieve the set point.

## Set Domestic Hot Water (DHW) Flow & Temperature

In order to get hot water from the combination boiler at the required temperature you must control the flow of cold water coming into the boiler. This can be achieved by either fitting a flow valve with a set flow rate (available in our EHS Installers Kit) or restricting the flow via the isolation valve to the cold inlet of the hot water side of the boiler or by using a flow restrictor on the incoming water supply. Please see below the recommended flow rates of cold water below for the differing sized boilers. These flow rates are based on a 30°C rise in temperature of incoming to outgoing water

Rated Combi Boiler Output	12kw	14kw
Recommended Flowrate (ltr/min)	5	6

### To Set the Hot water Temperature

- Open a Hot tap and let it run. The tap symbol  should light to confirm flow rate is above 3 l/m
- With the hot water tap open and running, the temperature of the hot water outlet can now be set on the boiler by using the up and down arrow buttons. If the property has a thermostatic shower installed, we recommend setting a maximum temperature of 50 degrees C. The temperature cannot be adjusted without a hot tap being open. Remember this setting does not guarantee the output, it only sets the maximum possible output, the output temperature will rely on the flow rate going into the boiler, the incoming temperature of the water and the supply voltage in the property. Our 14kw combi boilers will add about 30°C to the incoming water temperature at a flowrate of about 6.5 litres per minute.

## Final check for Heating and Hot water.

---

### HEATING CHECK

- Turn the thermostat to a temperature 5 degrees above current room temperature and check that the boiler heating fires. This is confirmed by the flame symbol and power curve lights on the display. You should be able to see the flow temperature start to rise.
- Let the boiler run for a few minutes and then check that the radiators are starting to heat up.
- After 15 minutes check the temperature difference between the flow and return is between 15C to 20C. If not adjust pump speed accordingly
- Wait until the thermostat reaches temperature and deactivates the boiler.
- Again, set the thermostat another 5 degrees higher and wait for a few minutes to check that the boiler successfully fires again.
- Bleed all radiators and refill system to 1.5bar pressure.
- Set the thermostat to normal operating temperature.

### Common Heating Start Up Issues:

1. If the pump symbol does not come on when your thermostat is calling for heat, firstly check that it is in winter mode (and not summer mode) and check you have the correct Zero-volt connections on the boiler wire in the thermostat receiver. To check, remove the boiler thermostat cable from the receiver and twist the two wires together. This will force the boiler to fire. If the pump comes on you have the wrong connections in the thermostat. Please read the manufacturer's instructions.
2. If the pump continues to cycle and then gives an F6 error, the boiler is protecting itself as it is not detecting any flow in the heating system. This is generally caused by air locks, a closed isolation valve or no ABV (automatic Bypass Valve) being fitted.

## HOT WATER CHECK

- Open a hot water tap. The TAP symbol should light in the top right of the display screen to indicate that the flow is above 3 litres per minute. The boiler will then show the flame symbol and you should be able to see the temperature rise.
- Give the boiler a few minutes to reach temperature. If the stable temperature is below the desired temperature, reduce the flow of cold water through the boiler as detailed in section 8. Close the hot water taps to complete testing.
- We recommend fitting a 5l/min flow restrictor (available in our fitter's kit at [www.ehs-heating.com](http://www.ehs-heating.com))

### Common Hot Water Start Up Issues:

1. Water Not hot enough – In this case the water flow to the boiler is too high. Reduce water flow to the boiler as detailed in above in Setting Hot water
2. Shower temperature fluctuating to cold and back on – In this case the cold water pressure is too high on the cold side of the shower or the set temp of the hot water is too high. Reduce hot water set temp to 48°C and try again.

## Registration for Warranty

---

The boiler can be registered for extended warranty by completing the requirements on the registration page on the website. Please use the QR code below to be start the registration process.



Note: The boiler must be fitted according to these installation instructions and our terms and conditions in order to qualify for extended warranty. Please be aware that if an engineer's callout is required there is a deposit required in order to confirm the visit and also to ensure that the boiler is fitted correctly. If you are in any doubt as to the fitting of the boiler please don't hesitate to contact us.

Please also be aware that our service helpline is **always** the quickest way to remedy any issues you are having with your hot water or heating system. Please don't hesitate to contact us by telephone on +44 345 8628699 or by email on [info@ehs-heating.co.uk](mailto:info@ehs-heating.co.uk) for free help and guidance.

# PLUMBERS CHECKLIST

---

COMPANY NAME.....

PLUMBERS NAME.....

COMPANY ADDRESS:.....

COMPANY TELEPHONE:.....

DATE OF INSTALLATION.....PRODUCT CODE.....

WAS THIS A EXISTING INSTALL OR NEW INSTALL?      EXISTING      NEW INSTALL

HOW MANY HEATING ZONES ARE INSTALLED?      1      2      3+

HAS THE FILLING LOOP BEEN REMOVED & CAPPED OFF?      YES      NO

WAS AN ABV FITTED? AT WHAT SETTING?      YES      NO      SETTING.....

WHAT IS THE HEATING PRESSURE SET AT?      .....Bar

WHAT IS THE INCOMMING MAINS PRESSURE?      .....Bar

WHAT HAS THE BOILER FLOW TEMPERATURE BEEN SET AT?      ..... o C

WHAT HAS THE BOILER DIFFERENTIAL TEMP. BEEN SET AT?.....o C

WHAT PUMP SPEED HAS BEEN SET ON THE BOILER? .....

Notes:-

BY SIGNING YOU AGREE THAT YOU HAVE INSTALLED THE BOILER IN ACCORDANCE WITH THIS MANUAL, HAVE READ THE WARRANTY CONDITIONS AND CAN CONFIRM THAT THE BOILER IS WORKING AS INTENDED WITHOUT ANY LEAKS AND ALL INSTALLER MADE AND FACTORY-MADE CONNECTIONS HAVE BEEN CHECKED

SIGNED: .....      DATE:.....

PRINT .....      .....

# ELECTRICIANS CHECKLIST

---

COMPANY NAME.....

ELECTRICIANS NAME.....

NICEIC REGISTRATION NUMBER.....

COMPANY ADDRESS:.....

COMPANY TELEPHONE:.....

DATE OF INSTALLATION:.....

WHAT IS THE TOTAL MAINS SUPPLY AT THE FUSE BOARD? AMPS

WHAT IS THE INCOMING MAINS VOLTAGE AT THE APPLIANCE? VAC

WHAT SIZE BREAKER HAS BEEN FITTED FOR THE BOILER? AMPS

WHAT IS THE DRAW OF THE APPLIANCE FOR HEATING? AMPS

WHAT IS THE DRAW OF THE APPLIANCE FOR HOT WATER? AMPS

WHAT SIZE CABLE WAS INSTALLED TO THE APPLIANCE? . MM2

WHAT IS THE APPROXIMATE CABLE RUN TO THE BOILER? M

WHAT TYPE OF CABLE HAS BEEN USED?

Notes:-

BY SIGNING YOU AGREE THAT YOU HAVE INSTALLED THE BOILER IN ACCORDANCE WITH THIS MANUAL, HAVE READ THE WARRANTY TERMS AND CONDITIONS AND CAN CONFIRM THAT THE BOILER IS WORKING AS INTENDED WITHOUT ANY LEAKS AND ALL INSTALLER MADE AND FACTORY-MADE CONNECTIONS HAVE BEEN CHECKED

SIGNED: ..... DATE:.....

PRINT .....



## Trouble Shooting For Qualified Installers

Error Code	Protection Function	Potential Cause	Potential Solution
<b>E2</b>	Electric leakage on system	Check whether the external power supply has leakage or whether there is condensation or water leakage on the main circuit board.	<ol style="list-style-type: none"> <li>1.Switch off the boiler</li> <li>2.Qualified engineer to open cover and dry/inspect circuit board.</li> </ol>
<b>E3</b>	Heating Water Temperature Sensor broken/loose	Sensor is in short circuit or open circuit.	<ol style="list-style-type: none"> <li>1.Check if the sensor connection is loose or not.</li> <li>2.If broken contact EHS customer service to replace sensor.</li> </ol>
<b>E5</b>	Domestic hot water temperature sensor broken	Sensor is in short circuit or open circuit.	<ol style="list-style-type: none"> <li>1. Check if the sensor connection is loose or not.</li> <li>2. If broken contact EHS customer service to replace sensor</li> </ol>
<b>E9</b>	Antifreeze fault	Heating water temperature is too low	<ol style="list-style-type: none"> <li>1. If the heating pipework is frozen, the boiler will not be able to work.</li> <li>2. Clean pipeline, refill the water then switch on.</li> </ol>
<b>EC</b>	Display Disconnected from PCB	Display Disconnected from PCB	<ol style="list-style-type: none"> <li>1. Check whether the connection between the cable and the PCB is broken or loosen.</li> <li>2. If broken Contact EHS customer service to replace cable/PCB.</li> </ol>
<b>F1</b>	Heat exchanger temperature sensor is reading over 90deg C Or is in open circuit (broken/disconnected). Heating is immediately stopped until exchanger has cooled.	<ul style="list-style-type: none"> <li>• Very low water flow in heat exchanger</li> <li>• Air trapped in heat exchanger</li> <li>• Airlock in heating system</li> <li>• Broken wire on sensor</li> </ul>	<ol style="list-style-type: none"> <li>1.Check whether the water flow circuit is ok or not.</li> <li>2.Check ABV is fitted correctly</li> <li>3.Check Isolating valves are open.</li> <li>4.Fill system and vent all high areas</li> <li>5.Fit auto vents in potential airtrap areas</li> <li>6. Press and hold TIME key for 6 seconds to reset</li> </ol>
<b>F2</b>	Heat too fast error	If rise $\geq 15^{\circ}\text{C}$ in 3s continuously	<ol style="list-style-type: none"> <li>1.Pipe blocked, the heat can't take away due to reduced water flow Solution: clear pipeline blockage</li> <li>2.Pump block or stuck.</li> </ol>

Error Code	Protection Function	Potential Cause	Potential Solution
			<p>Solution : repair or change pump</p> <p>3.The “DU” parameter too low</p> <p>Solution: increase” DU” software value</p>
<b>F4</b>	Water Pressure Fault	System is low on water	<ol style="list-style-type: none"> <li>1. Fill to correct pressure with filling loop</li> <li>2. Check whether the water pressure of the system drops and check for leaks.</li> <li>3. Check whether the pressure switch is blocked, or it has fault.</li> </ol>
<b>F6</b>	No water flow circulation	<p>Air in the system, no water or water</p> <p>pump not working, pump is blocked,</p> <p>water flow switch blocked, water</p> <p>flow switch is faulty.</p>	<ol style="list-style-type: none"> <li>1. Vent system. Put automatic vents in highest point of the return system.</li> <li>2. Check automatic bypass valve is installed and set correctly.</li> <li>3. Check system pressure.</li> <li>4. Check pump and flow switch for blockage/operation</li> </ol>
<b>E6</b>	Neutral wires not well connected	No heating	<ol style="list-style-type: none"> <li>1. Check whether the neutral wire of the machine has false connection.</li> <li>2. Check whether the neutral wire end of the leakage protection switch is damaged.</li> <li>3. Measure whether the voltage between the neutral wire and the live wire is 220 v.</li> <li>4.Contact the customer after sales to replace the motherboard.</li> </ol>
<b>No Power on display screen</b>	Thermal Trip on heating system heat exchanger activated. (Heat exchanger has reached 110C and bi-metallic thermal trip has activated)	<ul style="list-style-type: none"> <li>• Low or no water flow in the heating system. Before resetting the trip, solve the problem</li> </ul>	<ol style="list-style-type: none"> <li>1. Has the automatic bypass valve been fitted correctly and does it point from flow to return?</li> <li>2. Check all system filters and clean.</li> <li>3. Vent the system and install automatic air vents in the highest points of the return system</li> <li>4. Check the flow of water pump.</li> </ol>
<b>No Power on display screen</b>	External leakage protector tripped	<ol style="list-style-type: none"> <li>1. Incorrect trip switch installed or loose connection in trip switch</li> </ol>	<ol style="list-style-type: none"> <li>1. Electrician to Check the system for correct installation and fault find..</li> <li>2.</li> </ol>

Error Code	Protection Function	Potential Cause	Potential Solution
		or wrong size cable used	
	No heating	3. Equipment temperature does NOT rise.	<ol style="list-style-type: none"> <li>1. Water temperature setting too low.</li> <li>2. Differential temperature set too high.</li> <li>3. Timing and opening</li> <li>4. 4. Indoor temperature controller setting incorrect or set too low.</li> </ol>
	No Hot water	5. Thermal trip on heat exchanger activated or flow too low or faulty flow sensor or flow too high	<ol style="list-style-type: none"> <li>2. Electrician to check thermal trip</li> <li>3. Installer to check wiring and connections are good for Flow sensor</li> <li>6. Check flow is set to 6litres per minute</li> </ol>

# APPENDIX

## EHS System Boiler 1 Phase Heating Circuit Diagram

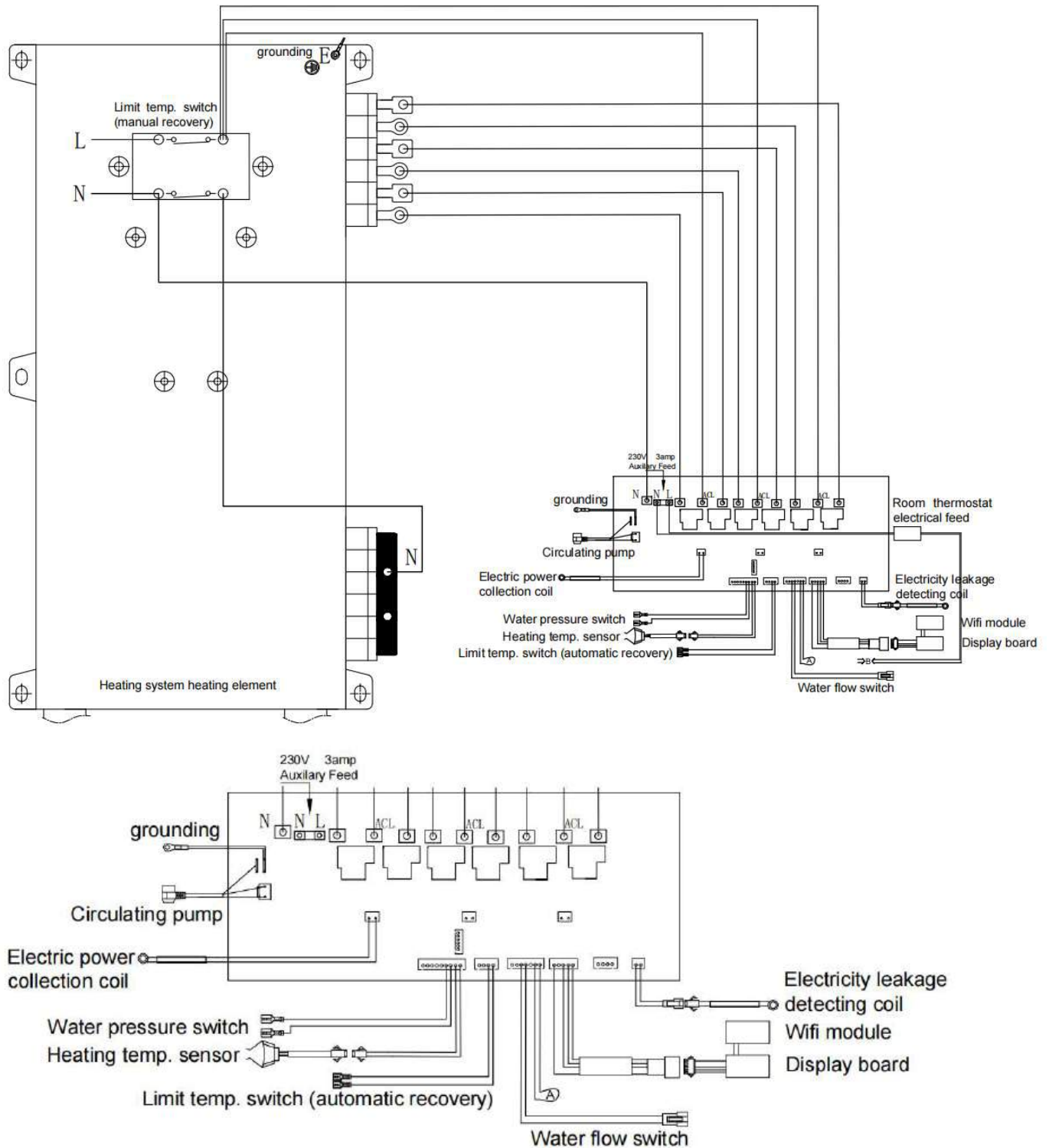

# EHS Combination Boiler 1 Phase Hot Water Circuit Diagram

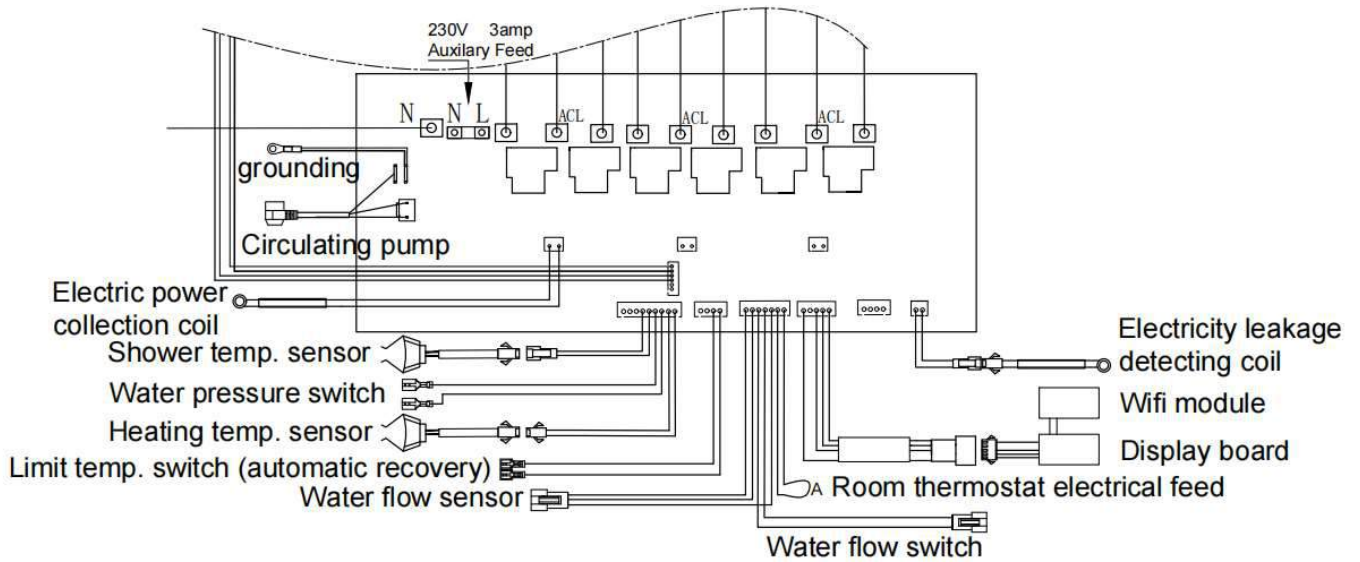
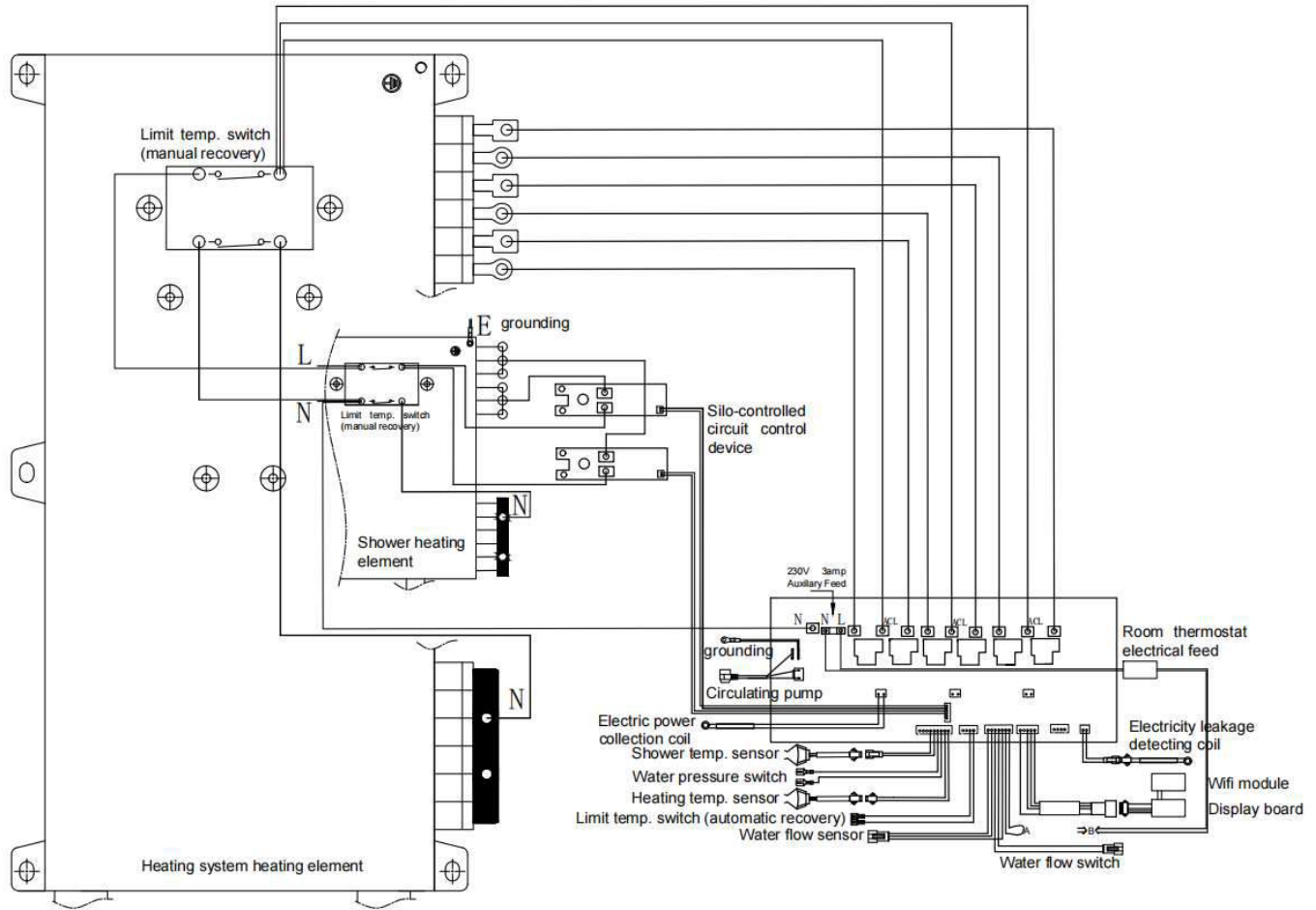

## Typical System Boiler S-Plan Wiring Centre Diagram for a Volt Free Boiler connection

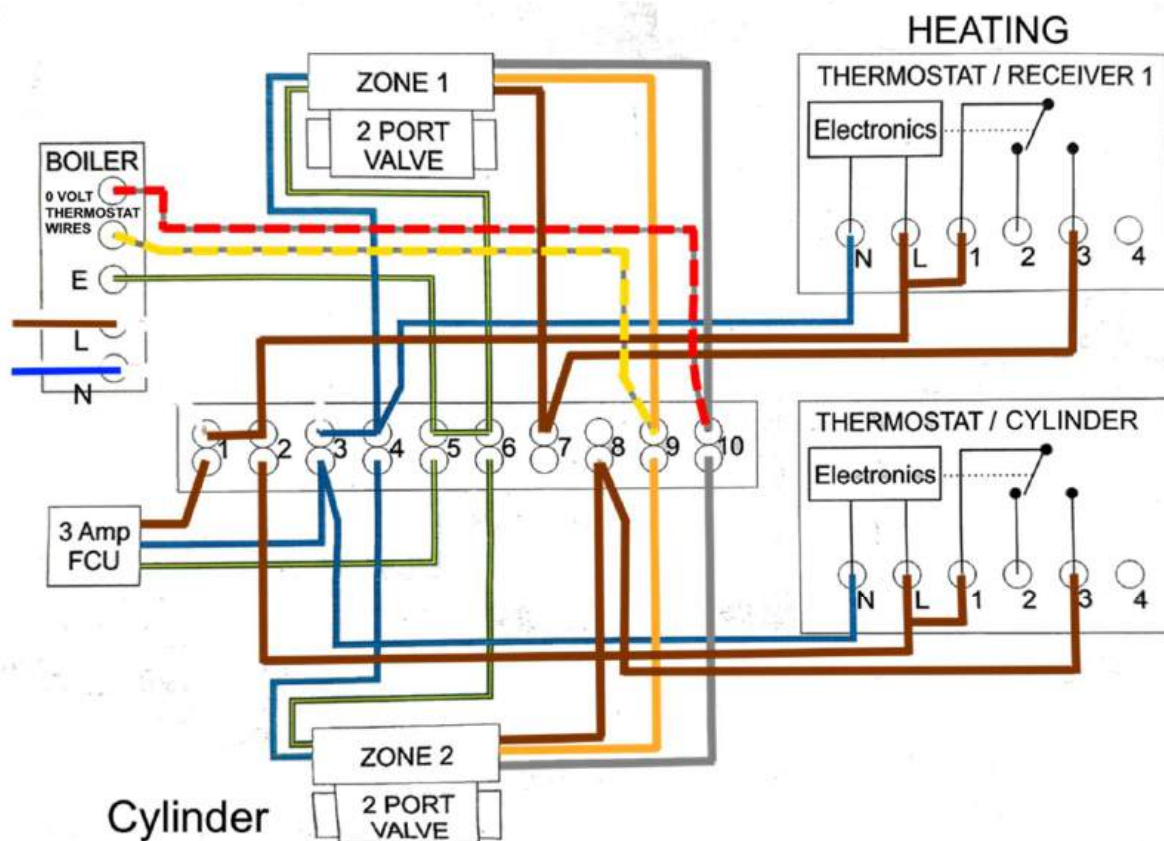

### Notes.

1. This is a guide. All wiring to be completed by a qualified professional and it is the responsibility of the installer to achieve a volt free connection.
2. The EHS Boilers have a black thermostat cable exiting from the bottom right of the boiler. This is a ZERO VOLT connection!! Do not wire any live voltage to this wire otherwise you'll blow the main circuit board
3. The orange and grey wires from the 2 port valves will usually provide the zero volt contact (the external thermostats drive the valves forward which creates that contact between orange and grey)
4. Please follow each individual manufacturers instructions for wiring of the thermostats (this is just a guide)
5. You must fit an automatic bypass valve between flow and return prior to the 2 port valves.



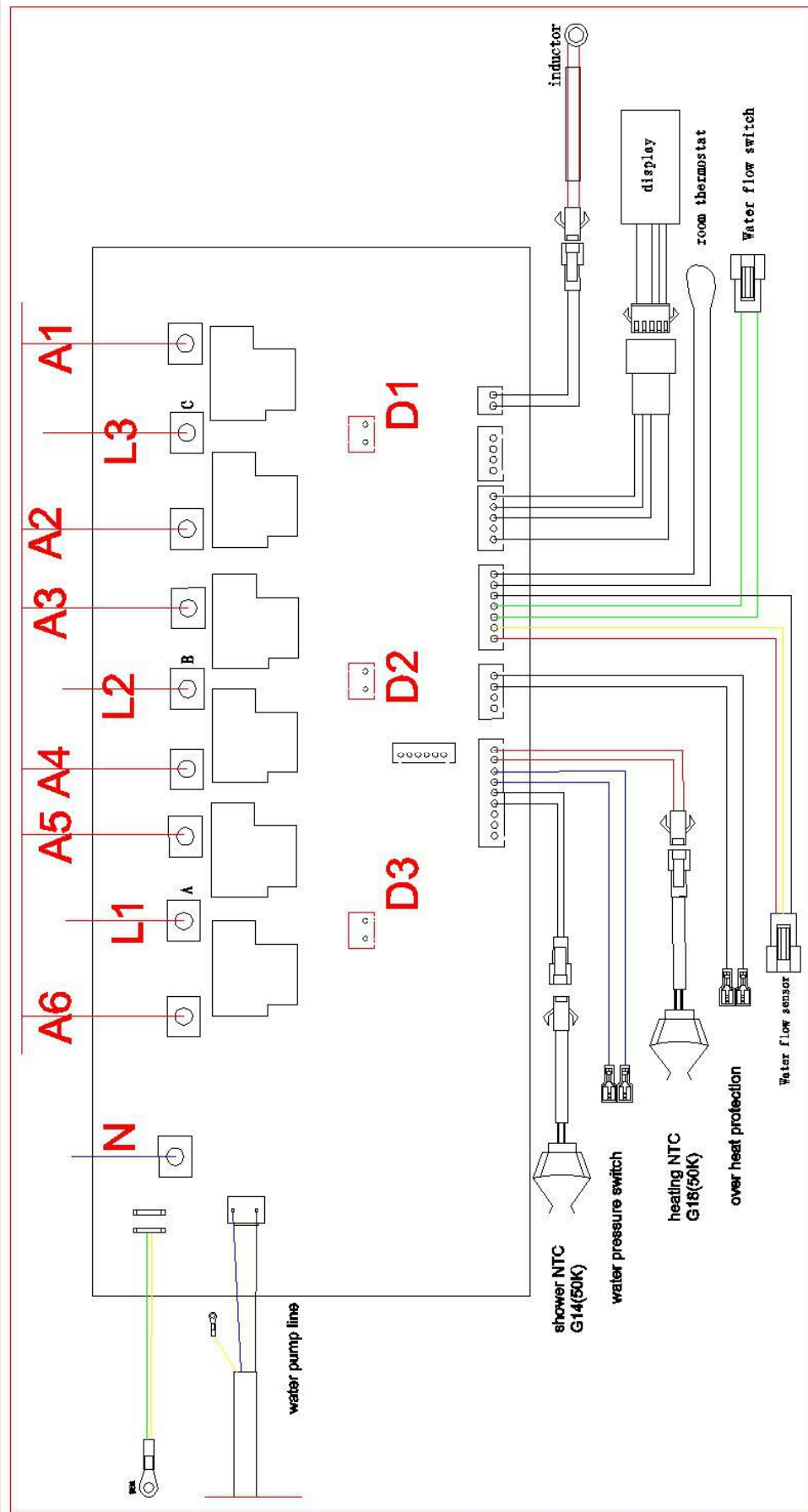

# Wiring Diagram for 3 Phase Boiler Heating Circuit

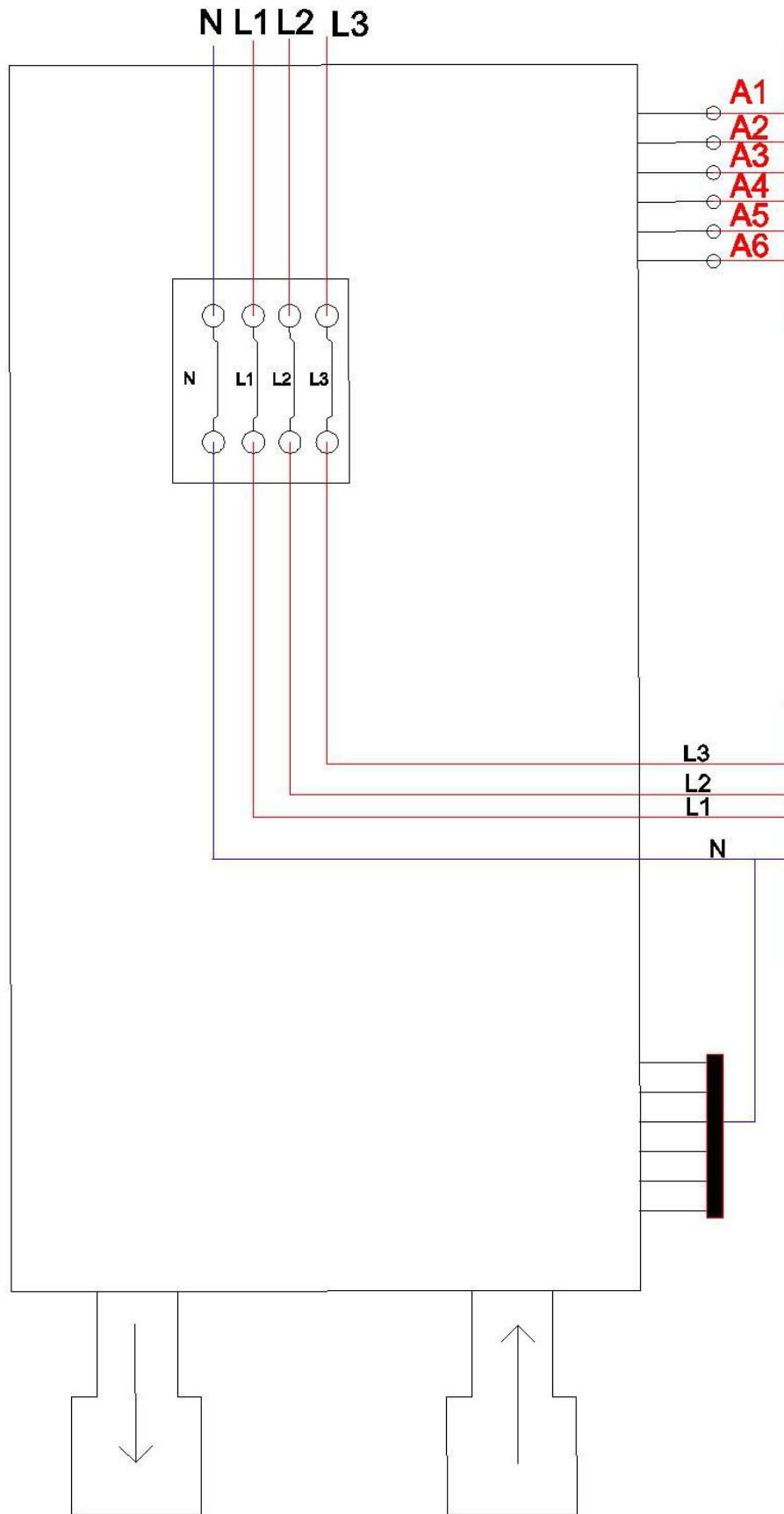

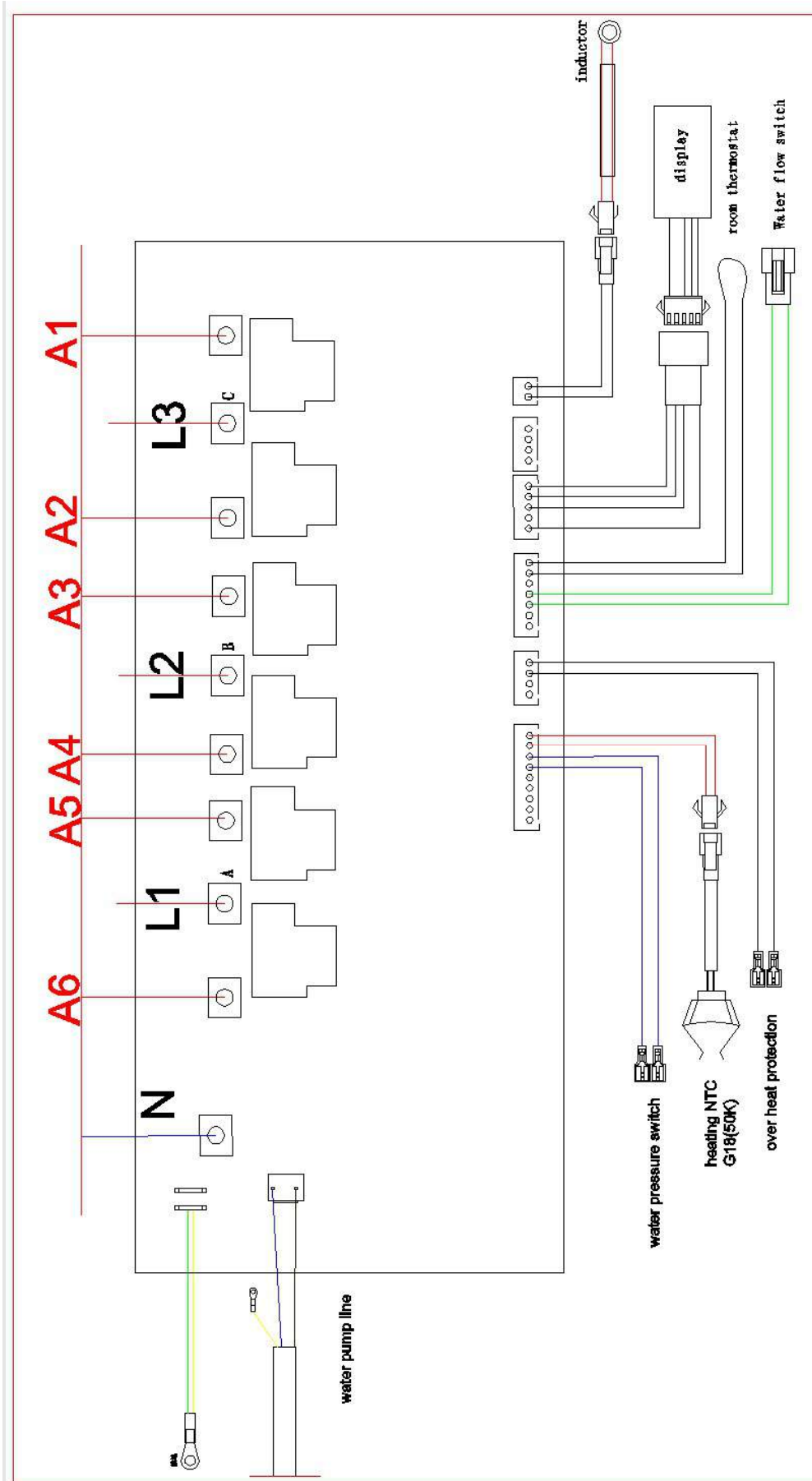

## Technical Data

Product Name	7KW EHS FLEX SYSTEM BOILER 2022	14KW EHS FLEX SYSTEM BOILER 2022	14KW EHS FLEX COMBI BOILER 2022	EHS 24KW FLEX SYSTEM BOILER (415V/3 PHASE)	EHS 24KW FLEX COMBI BOILER (415V/3 PHASE)
Heating Power	7KW	14KW	14KW	24KW	24KW
Hot Water Power	N/A	N/A	14KW	N/A	24KW
Function	Heating Only	Heating Only	Heating and Hot Water	Heating Only	Heating and Hot Water
IP Rating	IPX1	IPX1	IPX1	IPX1	IPX1
Hot Water flow rate (30deg rise in temp) l/m	NA	NA	6	NA	12
Cable size required	3x6mm <sup>2</sup>	3x10mm <sup>2</sup>	3x10mm <sup>2</sup>	5x6mm <sup>2</sup>	5x6mm <sup>2</sup>
Colour	White	White	White	White	White
EHS PART NO EHS	ALS1-1PSY-7F	ALS1-1PSY-14F	ALC1-1PCO-14F	ALS1-3PSY-24F	ALC1-3PCO-24F
Voltage	240v	240v	240v	415V	415V
Water Pressure	1~3 bar	1~3 bar	1~3 bar	1~3 bar	1~3 bar
Net Weight (kgs)	19	26	26	30	35
Gross Weight (kg)	22	29	29	31	36
Inlet & Outlet Connection	N/A	N/A	G1/2	N/A	G1/2
Flow and Return connection	G3/4"	G3/4"	G3/4"	G3/4"	G3/4"
Capacity of Expansion Tank	5L	5L	5L	5L	6L
Product Size EHS Combi Boiler	585mmX380mmX235mm	585mmX380mmX235mm	585mmX380mmX235mm	420mmX250mmX635	420mmX250mmX635
Box Size (cm)	700mmX485mmX310mm	700mmX485mmX310mm	700mmX485mmX310mm	730mmX510mmX350mm	730mmX510mmX350mm

## BOILER MAINTENANCE

EHS electric boilers require only minimum maintenance. Periodically check the following:

The heating system must be filled and maintained when the water is cold, between a pressure of 1 – 3 bar. Frequent refilling of the system can cause scaling, corrosion and damage to a heating system and should be avoided wherever possible. Regular pressure loss could be indicative of a leak within the system and should be investigated.

**UNDER NO CIRCUMSTANCES SHOULD THE BOILER BE SWITCHED ON WHEN THE SYSTEM IS DRY.**

The boiler contains an installed frost-protection program. For this to operate, power must be always supplied to the boiler.

Anti-freeze can be added to the heating system (no more than 20% by volume) if the boiler is going to be stood unused for long periods of time. Otherwise, the boiler should be disconnected from the electricity supply and the system fully drained to avoid any frost damage.

A yearly boiler service is recommended and is part of the warranty conditions. It will confirm that everything is working correctly.

## WARRANTY INFORMATION

All EHS products are supplied in accordance with standard Terms & Conditions (available on request or via our website). This Policy also applies in addition to our terms and conditions to any EHS electric Boilers and by fitting this product you are agreeing to be bound by these Terms & Conditions and this Policy. This Policy sets out the Warranty Period and exclusions which apply to Electric Boilers, for other products please see our website or their corresponding manuals. This Policy is subject to our Standard Terms and Conditions and should be read in conjunction with those terms. We reserve the right to amend this policy at any time.

Warranty Details:

Warranty and Liabilities

19. The installer must be suitably qualified to install products and all Commissioning Sheets & Annual Servicing Sheets require to be made available to us when requested.

20. The product must be installed as per the installation instructions.

21. The Warranty must be registered with EHS by either the Installer or the Householder, within 30 days of the Boiler being installed. Failure to do so will reset the Warranty Period to 1 Years for Parts and Labour only.

22. For products registered within the stated time frame, the 5 Year Warranty will comprise of 2 Years Parts and Labour with a further 3 years Parts only.

23. To comply with our Warranty Terms the product must be serviced each year as outlined in the product installation manual. The service must be carried out by a suitably qualified engineer and a record of that service kept by the owner. The service can be within a 30 day period of the anniversary of the last service, without invalidating the Warranty.

24. If the service is not carried out in accordance with the guidelines within the product installation manual, the Warranty cover will become void.

25. During the Warranty period, we will replace parts which were faulty from the date of purchase, at our discretion free of charge. Reasonable Labour costs will only be paid where the value has been pre-agreed and authorised by EHS prior to the repair.

26. This Warranty is limited to the purchased product only and does not include any connected products or systems.

27. If the product breaks down or is showing a fault and requires an engineer to visit, we may ask you to pay a deposit prior to the repair visit. We will return the deposit in full if we find a fault that is covered by the Warranty. We may keep the deposit if we cannot access your property at the agreed visit time or conditions mentioned in point 23 above of this Warranty have not been met. A responsible adult must be at the property to provide access to the Engineer.

28. Any repair carried out under the terms of this Warranty does not extend the Warranty beyond its original period.

29. The Warranty only applies to products bought and used in the United Kingdom.

30. For products installed in the Channel Islands and Isle of Man the only a 2 Year Parts & Labour Warranty is applicable.

31. Engineers will not carry out repairs if they think accessing the product would be a risk to Health and Safety. We will not be liable for any costs if there is a health and safety issue

32. There must be sufficient room for the Engineer to work (the minimum area is set out in the installation instructions). We will not accept responsibility for removing cupboards, kitchen units, trims etc to gain access for repairs.

33. This Warranty does not in any way affect your Statutory or Legal Rights.

34. A central heating inhibitor (Ferrox or equivalent) is required to be added to the system during installation and thereafter at regular intervals using the correct dosage.

35. A magnetic filter requires to be installed on the return of every Boiler. This must be cleaned at every yearly service.

36. Existing systems require to be pressure flushed correctly and final TDS reading recorded on the commissioning paperwork.

37. This Warranty does not cover the following:

- Parts which fail due to system debris, contamination and/or water quality issues,
- Boilers installed within mobile leisure accommodation. e.g., Boats, Mobile Caravans.
- Any extra costs incurred whilst undertaking a repair due to incorrect installation
- Products that have been moved from their original place of installation.
- Costs of each annual service, including consumable parts such as seals and chemical treatments (inhibitor etc.)
- Any repair that is needed because of anything other than a fault to the Boiler or failure of the Boiler itself.
- Any 3rd party damage, whether accidental, negligent, malicious, or otherwise.
- Theft or attempted theft.
- Any fault or failure in the heating system to which the Boiler is connected.
- Any other costs or expenses caused by or arising because of a repair.
- Any damage caused by hard water scale deposits or sludge resulting from corrosion.
- Any problems caused by inadequate supply of services such as electricity or water to the property including loss of power.
- Boilers where:
- EHS Genuine Parts have not been used in any service or repair or

- They have not been Installed and set up strictly in line with the installation instructions supplied with them (including the requirement to clean the system and add corrosion inhibitor in line with BS7593:1992); or
- They have not been maintained strictly in line with the maintenance instructions supplied with them.

## **EHS Customer Service**

Contact us on

Email – [Info@ehs-heating.com](mailto:Info@ehs-heating.com)

Phone- +44 (0)345 8628699